

Mikro-Platten-System, TITAN 1,2 mm Micro Plate System, TITANIUM 1,2 mm

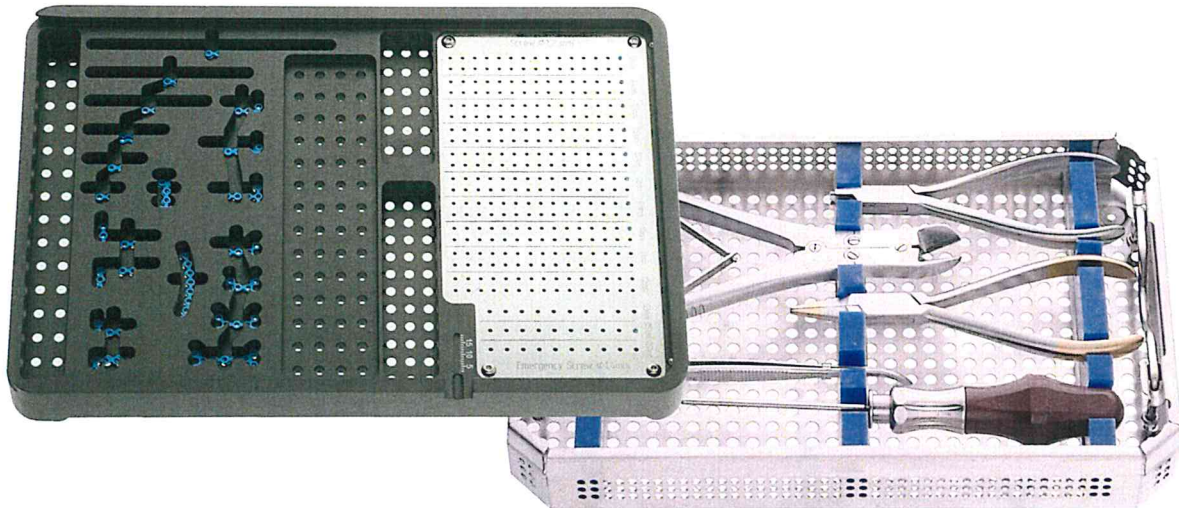

Set/300	Mikro-Platten-Standard-Set Standard Set Micro Plates komplett, bestehend aus: complete, consisting out of:	Platten je 5 Stück / Plates, 5 each:
29001-01	Sterilisier-Container 300x200x70 mm / Sterilisation Container 300x200x70 mm	18290-04 4-Loch / 4 holes 18290-06 6-Loch / 6 holes 18290-08 8-Loch / 8 holes 18290-12 12-Loch / 12 holes 18290-16 16-Loch / 16 holes 18290-24 24-Loch / 24 holes
29450-05	Rack für Instrumente / Rack for instruments	18290-40 5-Loch, rechts / 5 holes, right 18290-44 5-Loch, links / 5 holes, left 18290-50 8-Loch, rechts / 8 holes, right 18290-54 8-Loch, links / 8 holes, left 18290-60 5-Loch, 90° / 5 holes, 90° 18290-64 7-Loch, 90° / 7 holes, 90° 18290-70 6-Loch / 6 holes 18290-74 6-Loch / 6 holes 18290-75 7-Loch / 7 holes 18290-82 9-Loch / 9 holes 18290-86 Orbita-Platte 8-Loch / Orbital Plate, 8 holes
29451-05	Rack für Platten und Schrauben, TITAN Rack for plates and screws, TITANIUM	
18060-12	Plattenschneidezange mit Hartmetall, 12 cm Plate cutting pliers, with Tungsten Carbide inserts, 12 cm	
18406-15	Flachzange 13,5 cm / Flat pliers, 13,5 cm	
18050-03	Plattenbiegezange ADERER, 13 cm Plate bending pliers ADERER, 13 cm	
18153-01	Platten/Schrauben-Haltepinzette, TITAN, 15 cm Plates and screws holding forceps, TITANIUM, 15 cm	
18120-72	Schraubendreher selbsthaltend, 18 cm, für Kreuzschlitzschrauben Screw-driver, self holding, 18 cm, for cross head screws	
18199-04	1x Spiralbohrer Ø 1,0 x 46 mm mit Stryker-Ansatz 1x Twist drill Ø 1,0 x 46 mm with Stryker Coupling	
18199-08	1x Spiralbohrer Ø 1,0 x 50 mm mit Stryker-Ansatz 1x Twist drill Ø 1,0 x 50 mm with Stryker Coupling	
		Schrauben, je 10 Stück / Screws, 10 each:
		18292-04 Ø 1,2 x 4 mm 18292-05 Ø 1,2 x 5 mm 18292-06 Ø 1,2 x 6 mm 18292-07 Ø 1,2 x 7 mm 18292-08 Ø 1,2 x 8 mm 18292-09 Ø 1,2 x 9 mm 18292-11 Ø 1,2 x 11 mm 18292-55 Ø 1,4 x 5 mm Notfallschraube / Emergency screw

Gerne können Sie Ihr individuelles Set zusammenstellen.
Wir passen die Lagerungsracks entsprechend an.

You can always compose your individual set.
We will adapt the racks accordingly.

Mikro-Platten, TITAN, Profil 0,55 mm, 1,2 mm
Micro Plates, TITANIUM, Profil 0,55 mm, 1,2 mm

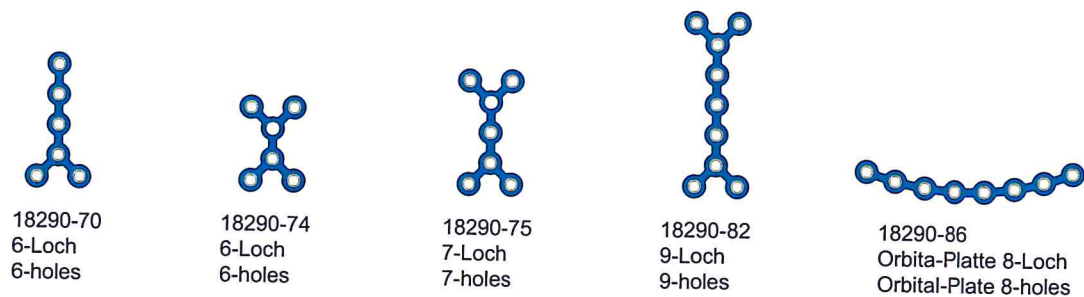
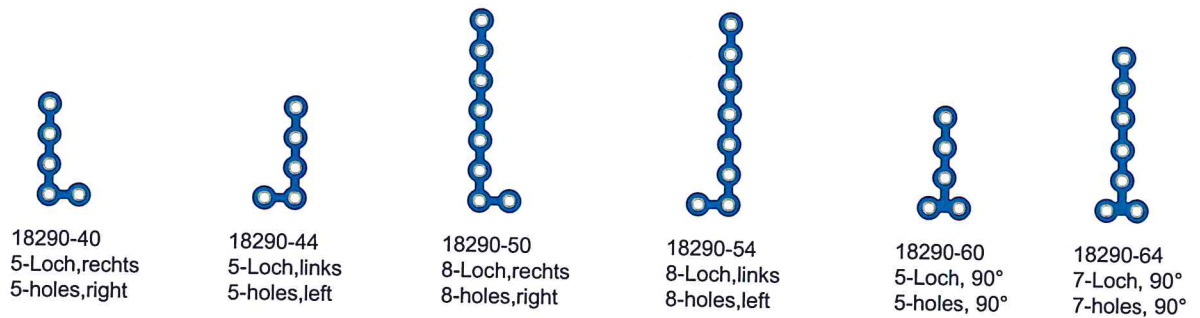
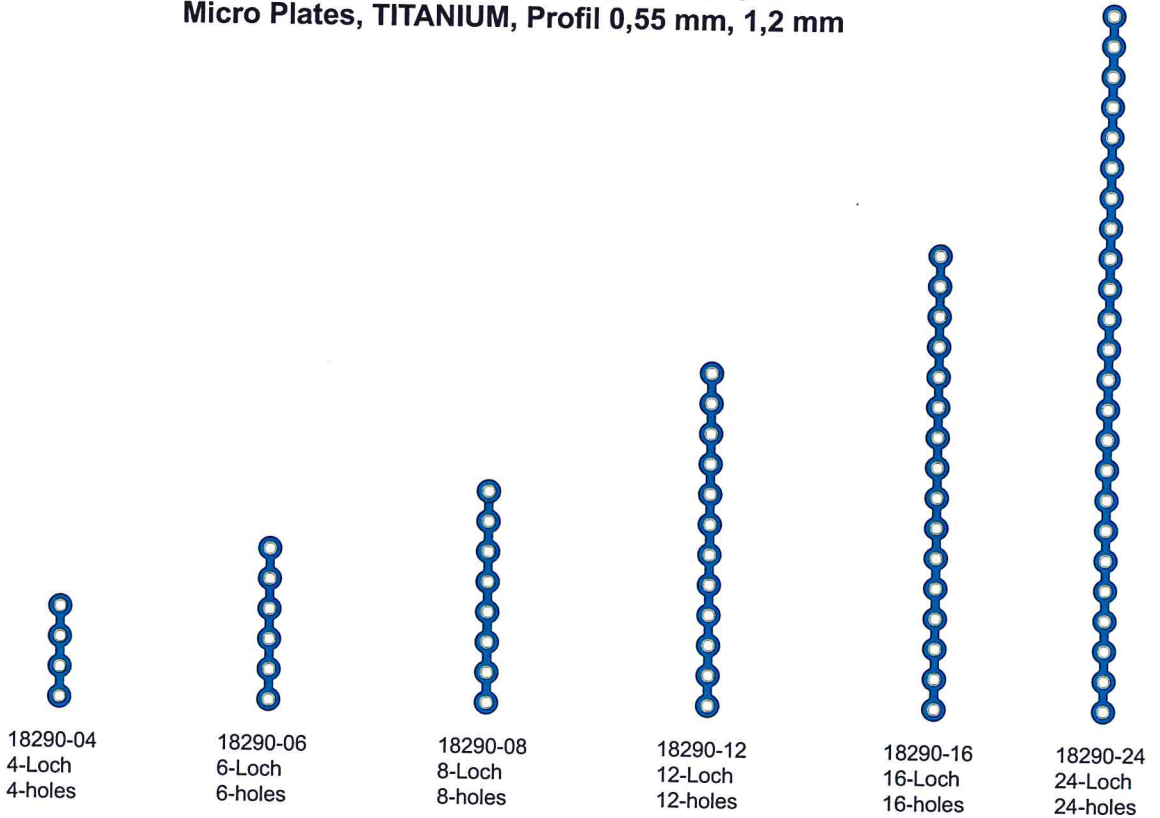

Mikro-Platten, TITAN, Profil 0,55 mm, 1,2 mm
Micro Plates, TITANIUM, Profil 0,55 mm, 1,2 mm



18290-90
2x2-Loch
2x2-holes



18290-92
2x2-Loch
2x2-holes



18290-94
3x2-Loch
3x2-holes



18290-96
3x2-Loch
3x2-holes



18290-98
4x2-Loch
4x2-holes

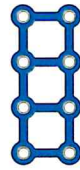

18291-00
4x2-Loch
4x2-holes



18291-04
4x2-Loch, Zygoma
4x2-holes, Zygoma

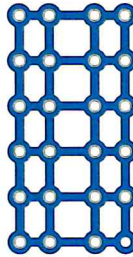

18291-08
6x4-Loch
6x4-holes

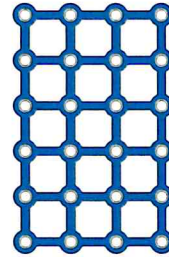

18291-12
6x4-Loch
6x4-holes

Gitter-Platten, TITAN
Mesh Plates, TITANIUM

18291-51	60 x 60 x 0,1 mm
18291-52	120 x 60 x 0,1 mm
18291-53	120 x 120 x 0,1 mm
18291-54	60 x 60 x 0,2 mm
18291-55	120 x 60 x 0,2 mm
18291-56	120 x 120 x 0,2 mm

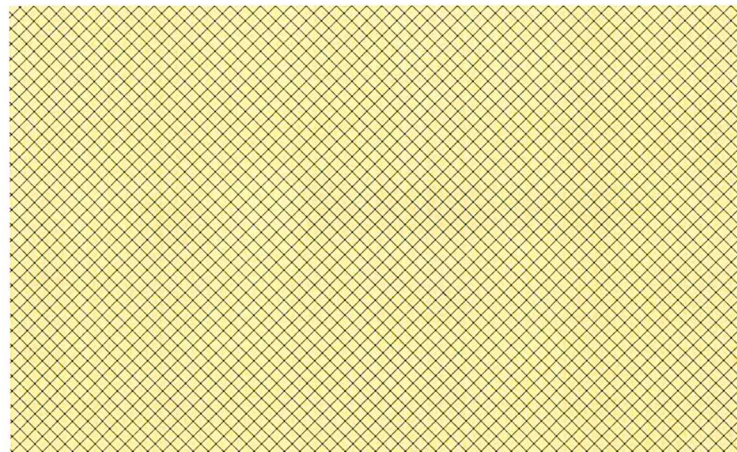

Gitter-Platten, TITAN
Mesh Plates, TITANIUM

18291-57	80 x 50 x 0,3 mm
18291-58	80 x 50 x 0,6 mm

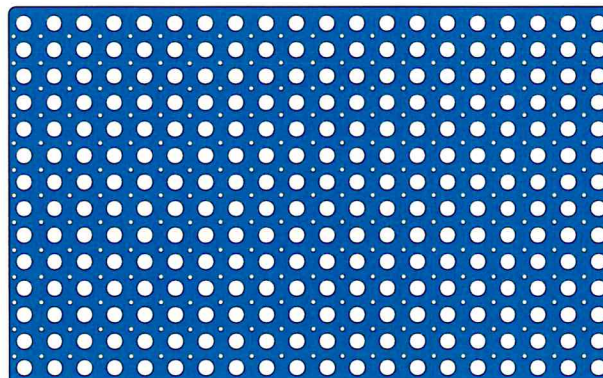

Mikro-Knochenschrauben, TITAN 1,2 mm
Micro Bone Screws, TITANIUM 1,2 mm



Kreuzschlitz
Cross Head

18292-02	Ø 1,2 x 2 mm
18292-03	Ø 1,2 x 3 mm
18292-04	Ø 1,2 x 4 mm
18292-05	Ø 1,2 x 5 mm
18292-06	Ø 1,2 x 6 mm
18292-07	Ø 1,2 x 7 mm
18292-08	Ø 1,2 x 8 mm
18292-09	Ø 1,2 x 9 mm
18292-10	Ø 1,2 x 10 mm
18292-11	Ø 1,2 x 11mm
18292-12	Ø 1,2 x 12mm
18292-13	Ø 1,2 x 13mm

Notfallschrauben
Emergency screws

18292-53	Ø 1,4 x 3 mm
18292-55	Ø 1,4 x 5 mm
18292-57	Ø 1,4 x 7 mm



Vierkant
Square head

18293-02	Ø 1,2 x 2 mm
18293-03	Ø 1,2 x 3 mm
18293-04	Ø 1,2 x 4 mm
18293-05	Ø 1,2 x 5 mm
18293-06	Ø 1,2 x 6 mm
18293-07	Ø 1,2 x 7 mm
18293-08	Ø 1,2 x 8 mm

Notfallschrauben
Emergency screws

18293-53	Ø 1,4 x 3 mm
18293-55	Ø 1,4 x 5 mm

Instrumente für Mikro-Platten-System, 1,2 mm
Instruments for Micro Plate System, 1,2 mm

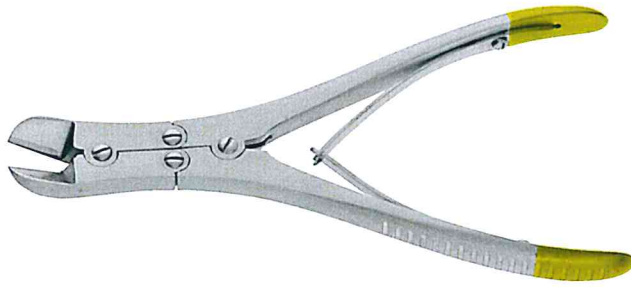

18060-12 Plattenschneidezange
12 cm, mit Hartmetall
Plate cutting pliers
12 cm, with Tungsten Carbide inserts

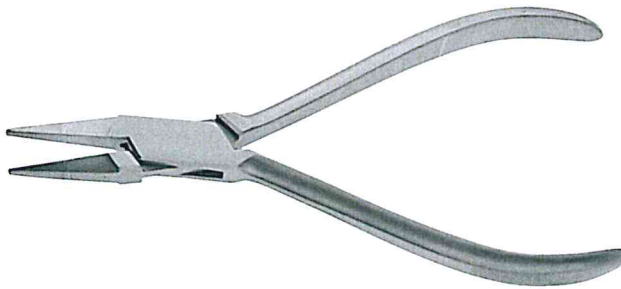

33406-15 Flachzange, 13,5 cm
Flat pliers, 13,5 cm



18050-03 Plattenbiegezange ADERER, 13 cm
Plate bending pliers ADERER, 13 cm



18153-01 Platten/Schrauben-Haltepinzette,
TITAN, 15 cm
Plates and screws holding forceps
TITANIUM, 15 cm

Instrumente für Mikro-Platten-System 1,2 mm
Instruments for Micro Plate System 1,2 mm



18120-61 Schraubendreher, 18 cm
 selbsthaltend, für Vierkantschrauben
 Screw-driver, 18 cm
 self-holding, for square head screws



18120-72 Schraubendreher, 18 cm
 selbsthaltend, für Kreuzschlitzschrauben
 Screw-driver handle
 self-holding, for cross head screws



18120-43 Schraubendrehergriff
 alleine, für alle Klingen
 Screw-driver handle
 only, for all blades



18120-77 Schraubendreherklinge
 alleine, selbsthaltend, für Vierkantschrauben
 Screw-driver blade
 only, self holding, for square head screws



18120-66 Schraubendreherklinge
 alleine, selbsthaltend, für Kreuzschlitzschrauber
 Screw-driver blade
 only, self-holding for cross head screws



Spiralbohrer mit Stryker-Ansatz
Twist Drill with Stryker Coupling

18199-04 Ø 1,0 x 46 mm
 für Schrauben bis 4 mm Länge
 for screws up to 4 mm length

18199-08 Ø 1,0 x 50 mm
 für Schrauben bis 8 mm Länge
 for screws up to 8 mm length

Spiralbohrer mit Dental-Ansatz

18199-14 Ø 1,0 x 30 mm
 für Schrauben bis 4 mm Länge
 for screws up to 4 mm length

18199-18 Ø 1,0 x 34 mm
 für Schrauben bis 8 mm Länge
 for screws up to 8 mm length

Medium-Platten-System, TITAN 1,7 mm Medium Plate System, TITANIUM 1,7 mm

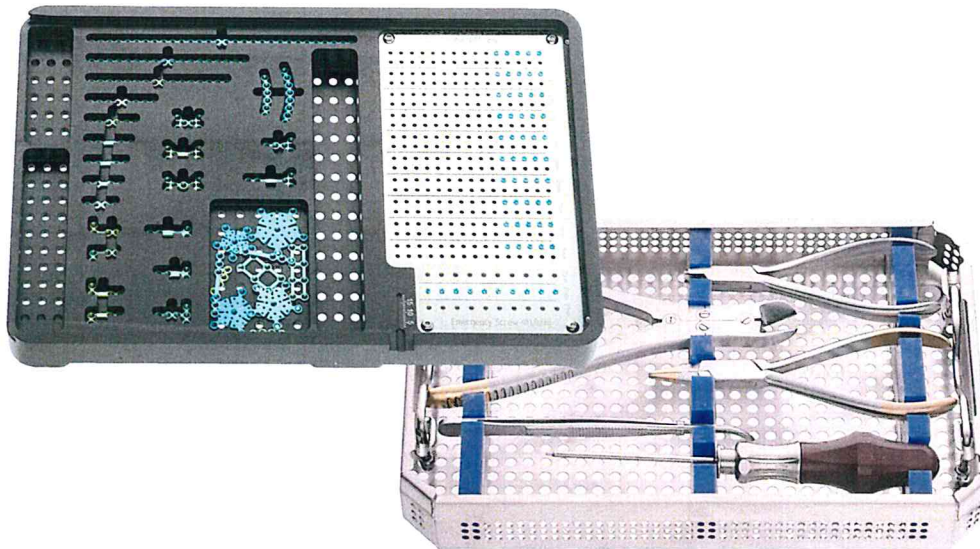

Set/301	Medium-Platten-Standard-Set Standard Set Medium Plates komplett, bestehend aus: complete, consisting out of:	Platten je 5 Stück / Plates, 5 each:	
29001-01	Sterilisier-Container 300x200x70 mm / Sterilisation Container 300x200x70 mm	18280-10	4-Loch / 4 holes
29450-10	Rack für Instrumente / Rack for instruments	18280-26	6-Loch / 6 holes
29451-10	Rack für Platten und Schrauben, TITAN Rack for plates and screws, TITANIUM	18280-48	8-Loch / 8 holes
18060-12	Plattenschneidezange mit Hartmetall, 12 cm Plate cutting pliers, with Tungsten Carbide inserts, 12 cm	18280-56	16-Loch / 16 holes
33406-15	Flachzange 13,5 cm / Flat pliers, 13,5 cm	18280-68	18-Loch / 18 holes
18050-05	Plattenbiegezange ADERER, 13 cm Plate bending pliers ADERER, 13 cm	18280-80	30-Loch / 30 holes
18153-01	Platten/Schrauben-Haltepinzette, TITAN, 15 cm Plates and screws holding forceps, TITANIUM, 15 cm	18281-14	4-Loch, rechts / 4 holes, right
18120-71	Schraubendreher selbsthaltend, 18 cm, für Kreuzschlitzschrauben Screw-driver, self holding, 18 cm, for cross head screws	18281-18	4-Loch, links / 4 holes, left
18201-05	1x Spiralbohrer Ø 1,3 x 47 mm mit Stryker-Ansatz 1x Twist drill Ø 1,3 x 47 mm with Stryker Coupling	18281-24	4-Loch, rechts / 4 holes, right
18201-08	1x Spiralbohrer Ø 1,3 x 50 mm mit Stryker-Ansatz 1x Twist drill Ø 1,3 x 50 mm with Stryker Coupling	18281-28	4-Loch, links / 4 holes, left
		18282-04	4-Loch, 90° / 4 holes, 90°
		18282-14	4-Loch, 90° / 4 holes, 90°
		18282-26	6-Loch / 6 holes
		18283-05	5-Loch / 5 holes
		18283-15	5-Loch / 5 holes
		18283-40	6-Loch / 6 holes
		18283-45	6-Loch / 6 holes
		18283-56	7-Loch / 7 holes
		18284-06	Orbita-Platte 6-Loch / Orbital Plate, 6 holes
		18284-08	Orbita-Platte 8-Loch / Orbital Plate, 8 holes
			Schrauben, je 10 Stück / Screws, 10 each:
		18398-03	Ø 1,7 x 3 mm
		18398-04	Ø 1,7 x 4 mm
		18398-05	Ø 1,7 x 5 mm
		18398-06	Ø 1,7 x 6 mm
		18398-07	Ø 1,7 x 7 mm
		18398-08	Ø 1,7 x 8 mm
		18398-09	Ø 1,9 x 5 mm Notfallschraube / Emergency screw
			Platten je 5 Stück / Plates, 5 each
		18280-04	4-Loch / 4 holes
		18280-06	4-Loch / 4 holes
		18280-08	4-Loch / 4 holes

Gerne können Sie Ihr individuelles Set zusammenstellen.
Wir passen die Lagerungsracks entsprechend an.

You can always compose your individual set.
We will adapt the racks accordingly.

Medium-Platten, TITAN, Profil 0,6 mm, 1,7 mm
Medium PLates, TITANIUM, Profile 0,6 mm, 1,7 mm

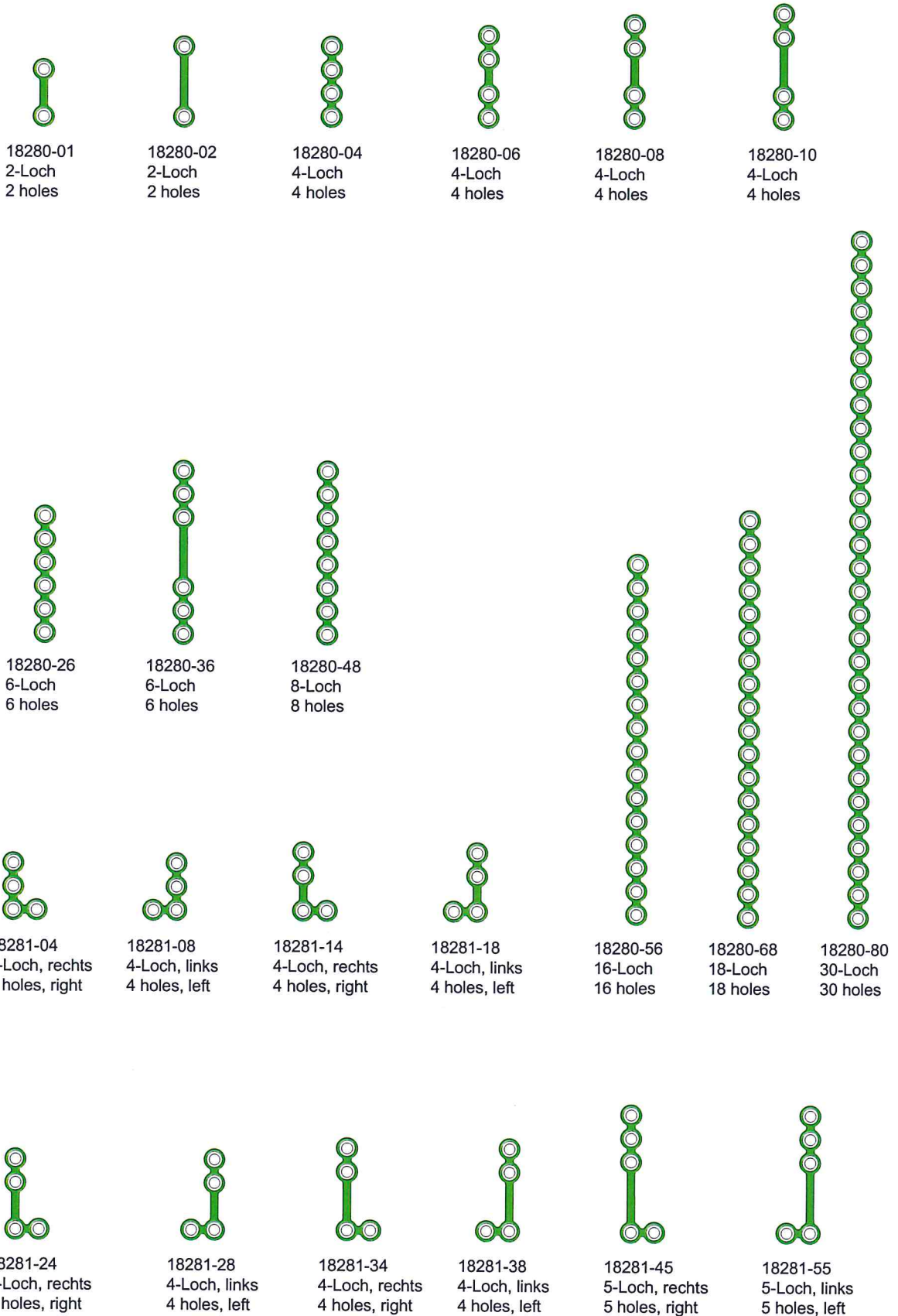

Medium Platten, TITAN, Profil 0,6 mm, 1,7 mm
Medium Plates, TITANIUM, Profile 0,6 mm, 1,7 mm



18282-04
4-Loch
4 holes



18282-14
4-Loch
4 holes

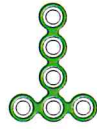

18282-26
6-Loch
6 holes



18282-25
5-Loch
5 holes



18282-46
6-Loch
6 holes



18283-05
5-Loch
5 holes



18283-15
5-Loch
5 holes

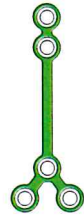

18283-25
5-Loch
5 holes



18283-40
6-Loch
6 holes



18283-45
6-Loch
6 holes



18283-56
7-Loch
7 holes



18284-04
4-Loch
4 holes



18284-06
6-Loch
6 holes



18284-08
8-Loch
8 holes

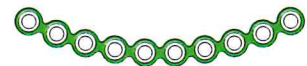

18284-10
10-Loch
10 holes

für Trepanation
for trepanation



18283-07
Ø 7 mm
Ø 7 mm

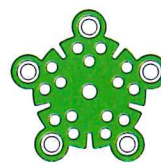

18283-10
Ø 10 mm
Ø 10 mm

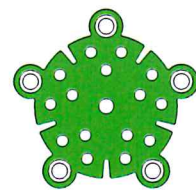

18283-14
Ø 14 mm
Ø 14 mm

Bohrlochplatten
Burr hole plates

Medium-Platten, TITAN, Profil 0,6 mm, 1,7 mm
Medium Plates, TITANIUM, Profile 0,6 mm, 1,7 mm



18286-34
2x2-Loch
2x2 holes



18286-04
2x2-Loch
2x2 holes

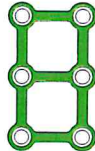

18286-36
3x2-Loch
3x2 holes

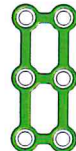

18286-06
3x2-Loch
3x2 holes

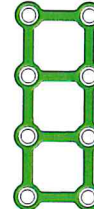

18286-38
4x2-Loch
4x2 holes

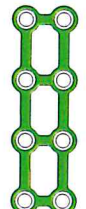

18286-08
4x2-Loch
4x2 holes

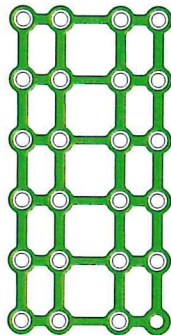

18286-24
6x4-Loch
6x4 holes

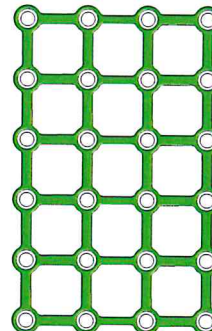

18286-54
6x4-Loch
6x4 holes

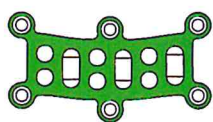

18286-70

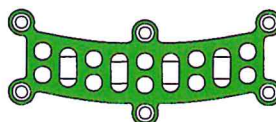

18286-72

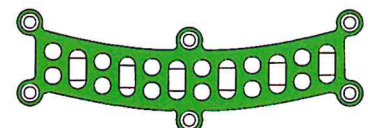

18286-74

Neuro-Spaltenplatten
Neuro gap plates

Medium-Platten, TITAN, Profil 0,6 mm, 1,7 mm
Medium Plates, TITANIUM, Profile 0,6 mm, 1,7 mm

18286-76 Neuro Sub-temporale Platte
Neuro sub temporal plate

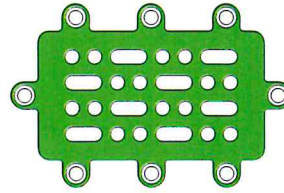

18286-80 Neuro Sub-temporale Platte
Neuro sub temporal plate

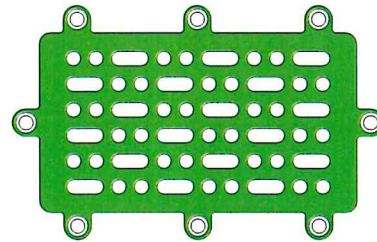

Gitter-Platten, TITAN
Mesh Plates, TITANIUM

18291-61 60 x 60 x 0,1 mm
18291-62 120x 60 x 0,1 mm
18291-63 120x 120 x 0,1 mm
18291-64 60x 60 x 0,2 mm
18291-65 120x 60 x 0,2 mm
18291-66 120x 120 x 0,2 mm

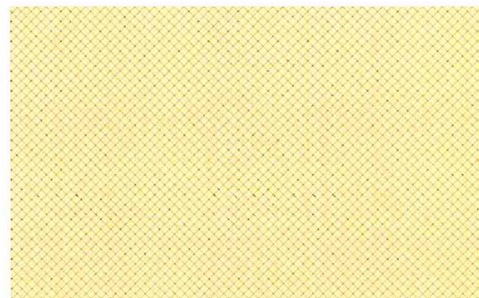

Gitter Platten, TITAN
Mesh Plates, TITANIUM

18251-67 80 x 50 x 0,3 mm
18251-68 80 x 50 x 0,6 mm

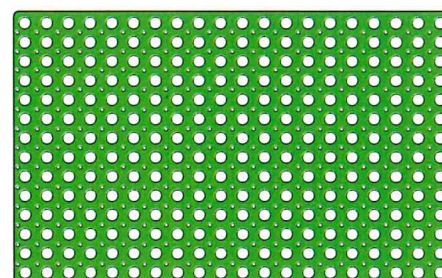

Medium-Knochenschrauben, TITAN 1,7 mm
Medium Bone Screws, TITANIUM 1,7 mm



Kreuzschlitz
Cross Head

18398-03	Ø 1,7 x 3 mm
18398-04	Ø 1,7 x 4 mm
18398-05	Ø 1,7 x 5 mm
18398-06	Ø 1,7 x 6 mm
18398-07	Ø 1,7 x 7 mm
18398-08	Ø 1,7 x 8 mm
18398-11	Ø 1,7 x 11 mm
18398-13	Ø 1,7 x 13 mm
18398-15	Ø 1,7 x 15 mm

Notfallschrauben
Emergency screws

18398-55	Ø 1,9 x 5 mm
----------	--------------



Vierkant
Square head

18399-03	Ø 1,7 x 3 mm
18399-04	Ø 1,7 x 4 mm
18399-05	Ø 1,7 x 5 mm
18399-06	Ø 1,7 x 6 mm
18399-07	Ø 1,7 x 7 mm
18399-08	Ø 1,7 x 8 mm
18399-09	Ø 1,7 x 9 mm
18399-11	Ø 1,7 x 11 mm
18399-13	Ø 1,7 x 13mm
18399-15	Ø 1,7 x 15mm

Notfallschrauben
Emergency screws

18399-55	Ø 1,9 x 5 mm
18399-57	Ø 1,9 x 7 mm

Instrumente für Medium-Platten-System, 1,7 mm
Instruments for Medium Plate System, 1,7 mm

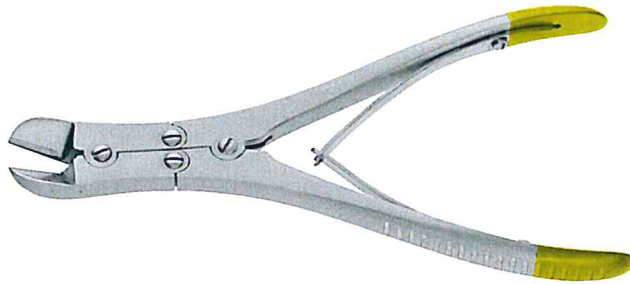

18060-12 Plattenschneidezange
12 cm, mit Hartmetall
Plate cutting pliers
12 cm, with Tungsten Carbide inserts

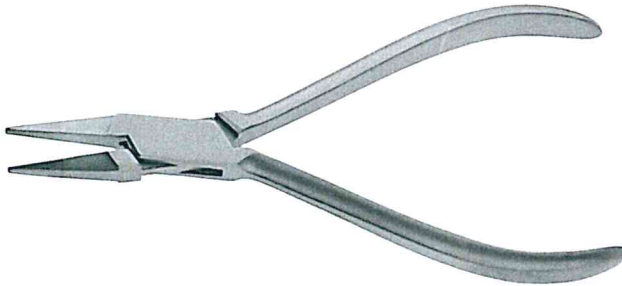

33406-15 Flachzange, 13,5 cm
Flat pliers, 13,5 cm

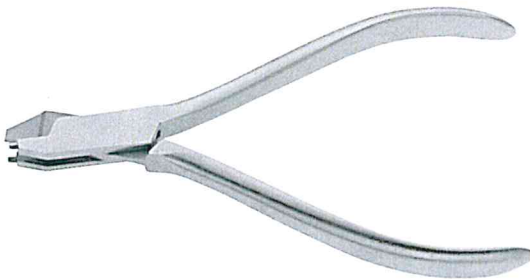

18050-03 Plattenbiegezange ADERER, 13 cm
Plate bending pliers ADERER, 13 cm



18153-01 Platten/Schrauben-Haltepinzette,
TITAN, 15 cm
Plates and screws holding forceps
TITANIUM, 15 cm

Instrumente für Medium-Platten-System, 1,7 mm
Instruments for Medium Plate System, 1,7 mm

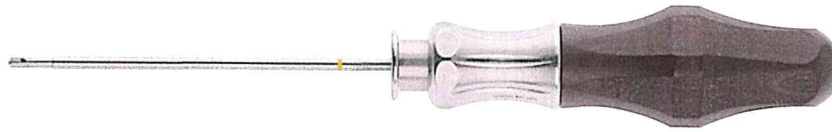

18120-60

Schraubendreher, 18 cm
 selbsthaltend, für Kreuzschlitz
 für Titan Schrauben Ø 1,7 mm
Screw-driver, 18 cm
 selfretaining, for cross lock
 for titan screws Ø 1,7 mm



18120-71

Schraubendreher, 18 cm
 selbsthaltend, für Vierkant
 für Titan Schrauben Ø 1,7 mm
Screw-driver, 18 cm
 selfretaining, for square lock
 for titan screws Ø 1,7 mm



18120-40

Schraubendrehergriff aus Ferozell
 drehbar für alle Sorten Klingen
Ferozell Screw-driver handle
 turnable, for all blades



18120-81

Schraubendreher Metallgriff
 drehbar, 15 cm, selbsthaltend, für Kreuzschlitz
 für Titanschrauben Ø 1,2 mm
Metal Screw-driver handle
 turnable, 15 cm, selfretaining, for cross lock
 for titan screws Ø 1,2 mm



18120-84

Schraubendreher Metallgriff
 drehbar, 15 cm, selbsthaltend, für Vierkant
 für Titanschrauben Ø 1,7 mm
Metal Screw-driver handle
 turnable, 15 cm, selfretaining, square lock
 for titan screws Ø 1,7 mm

Instrumente für Medium-Platten-System, 1,7 mm
Instruments for Medium Plate System, 1,7 mm



18121-15 Schraubendrehermetallgriff
 alleine, für Ø 1,7 mm Schraubendreherklingen
 Metal Screw-driver handle
 only for Ø 1,7 mm blades



18121-17 Schraubendreherklinge
 alleine, für Schrauben Ø 1,7 mm Kreuzschlitz
 Screw-driver blade
 only, for screws Ø 1,7 mm, cross lock



18121-19 Schraubendreherklinge
 alleine, für Schrauben Ø 1,7 mm Vierkant
 Screw-driver blade
 only, for screws Ø 1,7 mm, square lock



08513-05 Tiefenmesser, Messtiefe 50 mm
 Depth gauge, measuring depth 50 mm



Spiralbohrer mit Stryker-Ansatz
Twist Drill with Stryker Coupling

18201-05 Ø 1,3 x 50 mm
 für Schrauben bis 5 mm Länge
 for screws up to 5 mm length

18201-08 Ø 1,3 x 50 mm
 für Schrauben bis 8 mm Länge
 for screws up to 8 mm length

Spiralbohrer mit Dental Coupling
Twist Drill with Dental Coupling

18201-15 Ø 1,3 x 31 mm
 für Schrauben bis 5 mm Länge
 for screws up to 5 mm length

18201-18 Ø 1,3 x 34 mm
 für Schrauben bis 8 mm Länge for screws up to 8 mm length

Mini-Platten-System, TITAN, 2,0 mm Mini Plate System, TITANIUM, 2,0 mm

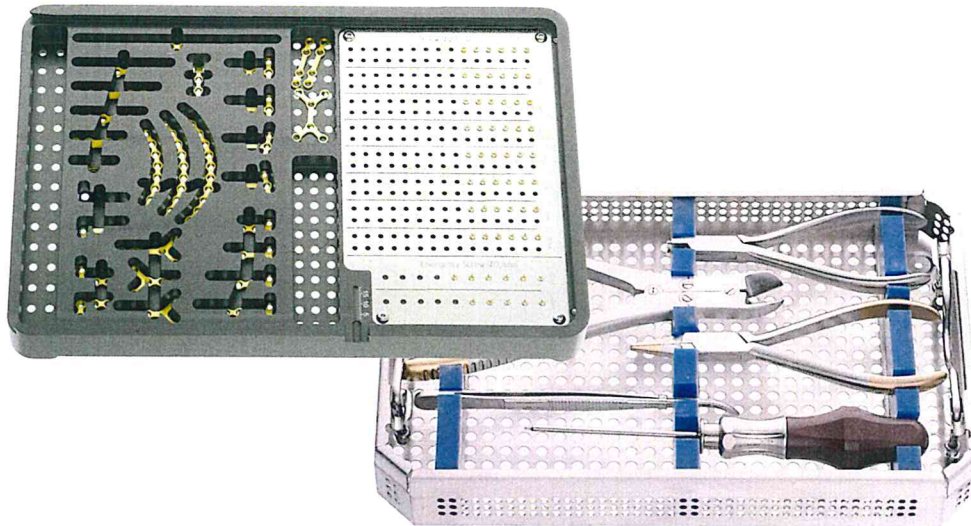

Set/302	Mini-Platten-Standard-Set Standard Set Mini Plates komplett, bestehend aus: complete, consisting out of:	Platten je 5 Stück / Plates, 5 each:
29001-01	Sterilisier-Container 300x200x70 mm / Sterilisation Container 300x200x70 mm	18360-03 12-Loch / 12 holes
29450-20	Rack für Instrumente / Rack for instruments	18300-04 4-Loch / 4 holes
29451-20	Rack für Platten und Schrauben, TITAN Rack for plates and screws, TITANIUM	18300-03 4-Loch / 4 holes
09501-17	Plattenschneidezange mit Hartmetall, 18 cm Plate cutting pliers, with Tungsten Carbide inserts, 18 cm	18300-06 6-Loch / 6 holes
33406-15	Flachzange 13,5 cm / Flat pliers, 13,5 cm	18301-04 6-Loch / 6 holes
18050-07	Plattenbiegezange ADERER, 13 cm Plate bending pliers ADERER, 13 cm	18300-08 8-Loch / 8 holes
18153-01	Platten/Schrauben-Haltepinzette, TITAN, 15 cm Plates and screws holding forceps, TITANIUM, 15 cm	18300-16 16-Loch / 16 holes
18124-00	Schraubendreher selbsthaltend, 18 cm, für Kreuzschlitzschrauben Screw-driver, self holding, 18 cm, for cross head screws	18330-04 4-Loch, rechts / 4 holes, right
18200-00	1x Spiralbohrer Ø 1,5 x 50 mm mit Stryker-Ansatz 1x Twist drill Ø 1,5 x 50 mm with Stryker Coupling	18340-04 4-Loch, links / 4 holes, left
18200-20	1x Spiralbohrer Ø 1,5 x 50 mm mit Stryker- Ansatz 1x Twist drill Ø 1,5 x 50 mm with Stryker Coupling	18330-14 4-Loch, rechts / 4 holes, right
		18340-14 4-Loch, links / 4 holes, left
		18324-05 5-Loch / 5 holes
		18323-06 6-Loch / 6 holes
		18320-04 4-Loch / 4 holes
		18221-04 4-Loch / 4 holes
		18321-06 6-Loch / 6 holes
		18325-05 5-Loch / 5 holes
		18326-05 5-Loch / 5 holes
		18350-04 6-Loch / 6 holes
		18310-05 5-Loch / 5 holes
		18311-06 5-Loch / 5 holes
		18311-05 5-Loch / 5 holes
		Schrauben, je 10 Stück / Screws, 10 each:
		18401-05 Ø 2,0 x 5 mm
		18401-07 Ø 2,0 x 7 mm
		18401-09 Ø 2,0 x 9 mm
		18401-11 Ø 2,0 x 11 mm
		18401-13 Ø 2,0 x 13 mm
		18401-15 Ø 2,0 x 15 mm
		18401-17 Ø 2,0 x 17 mm
		18411-07 Ø 2,3 x 7 mm Notfallschraube / Emergency screw

Platten je 5 Stück / Plates, 5 each

18360-01	8-Loch / 8 holes
18360-02	10-Loch / 10 holes

Gerne können Sie Ihr individuelles Set zusammenstellen.
Wir passen die Lagerungsracks entsprechend an.

You can always compose your individual set.
We will adapt the racks accordingly.

Mini-Platten, TITAN, Profil 0,6 mm, 2,0 mm
Mini Plate, TITANIUM, Profile 0,6 mm, 2,0 mm



18296-00
4-Loch
4 holes



18296-04
4-Loch
4 holes



18296-08
4-Loch
4 holes



18296-12
6-Loch
6 holes



18296-16
8-Loch
8 holes



18296-20
4-Loch, rechts
4 holes, right



18296-24
4-Loch, links
4 holes, left



18296-28
4-Loch, rechts
4 holes, right



18296-32
4-Loch, links
4 holes, left



18296-36
4-Loch, rechts
4 holes, right



18296-40
4-Loch, links
4 holes, left



18296-44
5-Loch, rechts
5 holes, right



18296-46
5-Loch, links
5 holes, left



18296-50
6-Loch, rechts
6 holes, right



18296-54
5-Loch, links
5 holes, left



18296-60
6-Loch, rechts
6 holes, right

Mini-Platten, TITAN, Profil 0,6 mm, 2,0 mm
Mini Plate, TITANIUM, Profile 0,6 mm, 2,0 mm

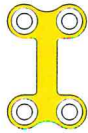

18296-56
4-Loch
4 holes

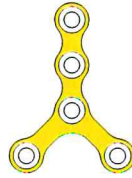

18296-64
5-Loch
5 holes



18296-68
5-Loch
5 holes

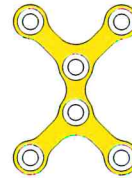

18296-72
6-Loch
6 holes



18296-76
6-Loch
6 holes



Orbita-Platten
Orbital Plates
18360-01
8-Loch
8 holes

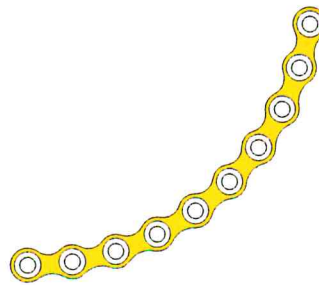

18360-02
10-Loch
10 holes

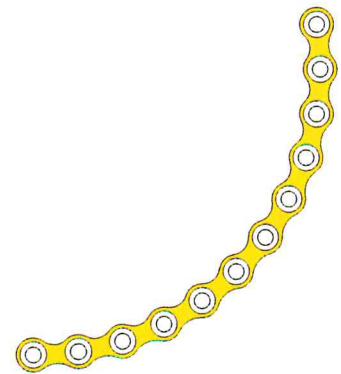

18360-03
12-Loch
12 holes

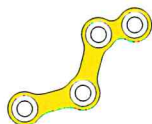

18296-90
4-Loch, rechts
4 holes, right



18296-88
4-Loch, links
4 holes, left



18296-92
4-Loch, rechts
4 holes, right

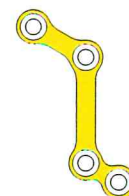

18296-94
4-Loch, links
4 holes, left

Mini-Platten, TITAN, Profil 1,0mm, 2,0 mm
Mini Plate, TITANIUM, Profile 1,0 mm, 2,0 mm



18300-04
4-Loch
4 holes



18300-03
4-Loch
4 holes

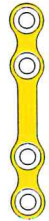

18301-04
4-Loch
4 holes

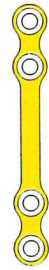

18301-05
4-Loch
4 holes



18300-06
6-Loch
6 holes



18301-06
6-Loch
6 holes



18300-08
8-Loch
8 holes



18300-12
12-Loch
12 holes



18300-16
16-Loch
16 holes



18300-24
24-Loch
24 holes



18300-40
40-Loch
40 holes



18330-04
4-Loch, rechts
4 holes, right



18340-04
4-Loch, links
4 holes, left



18330-14
4-Loch, rechts
4 holes, right



18340-14
4-Loch, links
4 holes, left



18331-04
4-Loch, rechts
4 holes, right



18341-04
4-Loch, links
4 holes, left



18331-14
5-Loch, rechts
5 holes, right



18341-14
5-Loch, links
5 holes, left

Mini-Platten, TITAN, Profil 1,0 mm, 2,0 mm
Mini Plate, TITANIUM, Profile 1,0 mm, 2,0 mm



18380-01
4-Loch, rechts
4 holes, right



18390-04
4-Loch, links
4 holes, left



18381-01
4-Loch, rechts
4 holes, right



18391-01
4-Loch, links
4 holes, left



18324-05
5-Loch
5 holes

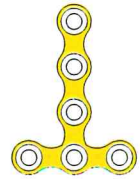

18323-06
6-Loch
6 holes



18320-04
4-Loch
4 holes



18321-04
4-Loch
4 holes

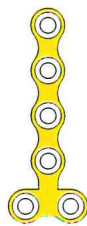

18321-06
6-Loch
6 holes



18322-06
6-Loch
6 holes



18325-05
5-Loch
5 holes

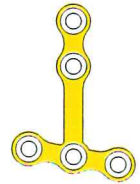

18326-05
5-Loch
5 holes



18350-04
6-Loch
6 holes

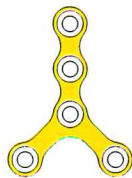

18310-05
5-Loch
5 holes

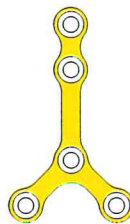

18311-06
5-Loch
5 holes

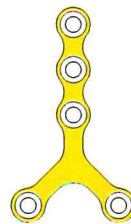

18311-05
5-Loch
5 holes

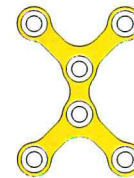

18312-23
6-Loch
6 holes



18314-30
6-Loch
6 holes



18312-07
7-Loch
7 holes



18319-50
4-Loch
4 holes

für Trepanation
for trepanation



18394-07
Ø 7 mm
Ø 7 mm

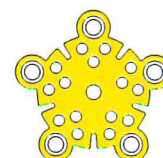

18394-10
Ø 10 mm
Ø 10 mm

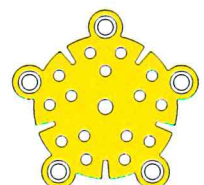

18394-14
Ø 14 mm
Ø 14 mm

Bohrlochplatten
Burr hole plates

Mini-Platten, TITAN, Profil 1,0 mm, 2,0 mm
Mini Plate, TITANIUM, Profile 1,0 mm, 2,0 mm

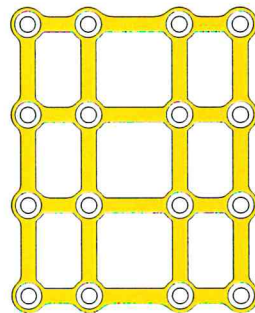
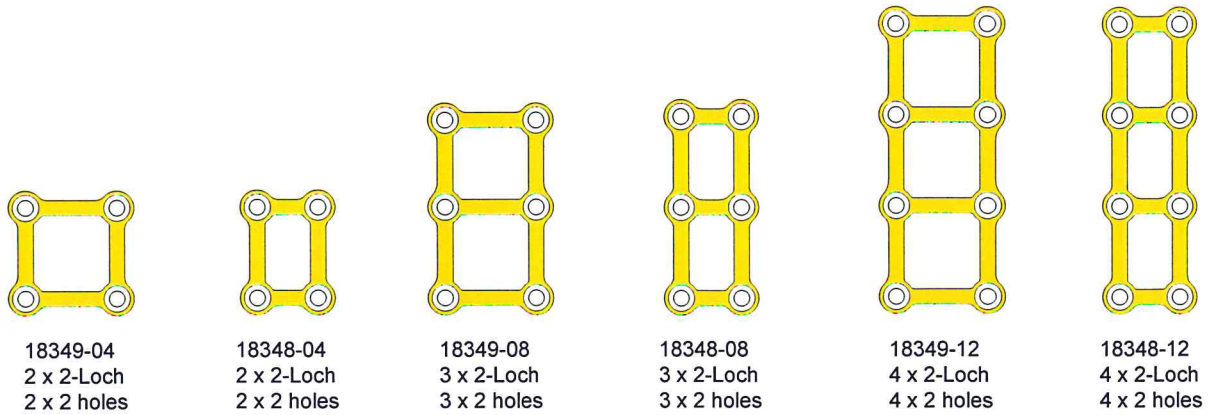

18348-20
4 x 4-Loch
4 x 4 holes

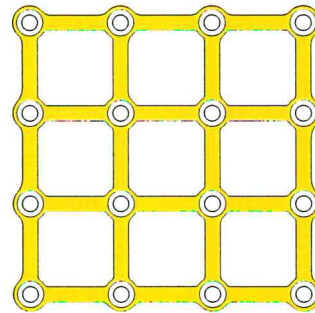

18349-20
4 x 4-Loch
4 x 4 holes

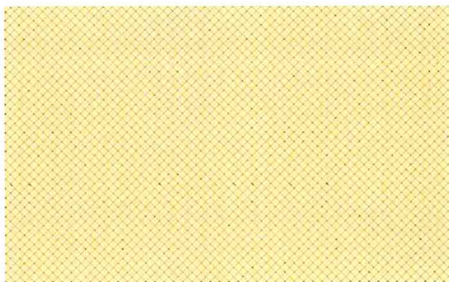

Gitter-Platten, TITAN
Mesh Plates, TITANIUM







18291-71	60 x 60 x 0,1 mm
18291-72	120 x 60 x 0,1 mm
18291-73	120 x 120 x 0,1 mm
18291-74	60 x 60 x 0,2 mm
18291-75	120 x 60 x 0,2 mm
18291-76	120 x 120 x 0,2 mm

18291-77 80 x 50 x 0,3 mm

TITAN-Draht
TITANIUM wires

18291-84	0,4 mm
18291-85	0,5 mm
18291-86	0,6 mm

Mini-Knochenschrauben, 2,0 mm
Mini Bone Screws, 2,0 mm

			Schlitz/Pin Single slot
		18400-04	Ø 2,0 x 4 mm
		18400-05	Ø 2,0 x 5 mm
		18400-07	Ø 2,0 x 7 mm
		18400-09	Ø 2,0 x 9 mm
		18400-11	Ø 2,0 x 11 mm
		18400-13	Ø 2,0 x 13 mm
		18400-15	Ø 2,0 x 15 mm
		18400-17	Ø 2,0 x 17 mm
			Notfallschraube Emergency screw
18410-07	Ø 2,3 x 7 mm		
			Kreuzschlitz Cross head
		18401-04	Ø 2,0 x 4 mm
		18401-05	Ø 2,0 x 5 mm
		18401-07	Ø 2,0 x 7 mm
		18401-09	Ø 2,0 x 9 mm
		18401-11	Ø 2,0 x 11 mm
		18401-13	Ø 2,0 x 13 mm
		18401-15	Ø 2,0 x 15 mm
		18401-17	Ø 2,0 x 17 mm
			Notfallschraube Emergency screw
18411-05	Ø 2,3 x 5 mm		
18411-07	Ø 2,3 x 7 mm		
			Vierkant Square head
		18402-04	Ø 2,0 x 4 mm
		18402-05	Ø 2,0 x 5 mm
		18402-07	Ø 2,0 x 7 mm
		18402-09	Ø 2,0 x 9 mm
		18402-11	Ø 2,0 x 11 mm
		18402-13	Ø 2,0 x 13 mm
		18402-15	Ø 2,0 x 15 mm
		18402-17	Ø 2,0 x 17 mm
			Notfallschraube Emergency screw
18402-55	Ø 2,3 x 5 mm		
18402-57	Ø 2,3 x 7 mm		

Instrumente für Mini-Platten-System, 2,0 mm
Instruments for Mini Plate System, 2,0 mm



09501-17 Plattenschneidezange
18 cm, mit Hartmetall
Plate cutting pliers
18 cm, with Tungsten Carbide inserts



33406-15 Flachzange, 13,5 cm
Flat pliers, 13,5 cm

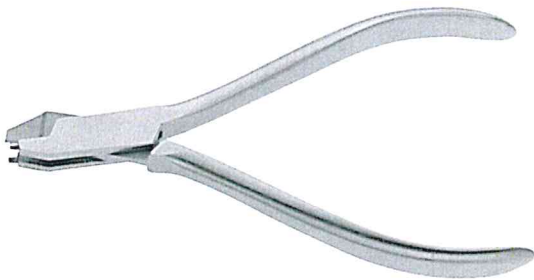

18050-07 Plattenbiegezange ADERER, 13 cm
Plate bending pliers ADERER, 13 cm



18051-15 Plattenbiegezange
13,5 cm, mit Stift
Plate bending pliers
13,5 cm, with pin



18153-01 Platten/Schrauben-Haltepinzette
TITAN, 15 cm
Plates and screws holding forceps
TITANIUM, 15 cm

Instrumente für Mini-Platten-System, 2,0 mm
Instruments for Mini Plate System, 2,0 mm

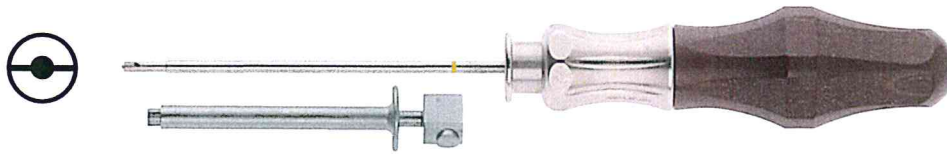

18120-00 Schraubendreher, drehbar
 mit Haltevorrichtung, für Schrauben Ø 2,0 mm
 mit Schlitz und Bohrung
 Screw-driver, turnable
 with holding device, for screws Ø 2,0 mm
 with slot and holding

18121-00 Schraubendreher
 mit Haltevorrichtung, für Schrauben Ø 2,0 mm
 mit Schlitz und Bohrung
 Screw-driver, turnable
 with holding device, for screws Ø 2,0 mm
 with slot and holding



18120-10 Schraubendreher, Kreuzschlitz, drehbar,
 selbsthaltend für Schrauben Ø 2,0 mm
 Screw-driver, crosslock,
 selfretaining, for screws Ø 2,0 mm

18120-11 Schraubendreher, Kreuzschlitz, fest,
 selbsthaltend für Schrauben Ø 2,0 mm
 Screw-driver, crosslock, selfretaining,
 firm for screws Ø 2,0 mm



18120-20 Schraubendreher, Vierkant, drehbar
 selbsthaltend für Schrauben 2,0 mm
 Screw-driver, crosslock, turnable
 selfretaining, for screws Ø 2,0 mm

18120-21 Schraubendreher, Vierkant, fest,
 selbsthaltend für Schrauben 2,0 mm
 Screw-driver, crosslock, selfretaining,
 firm for screws Ø 2,0 mm

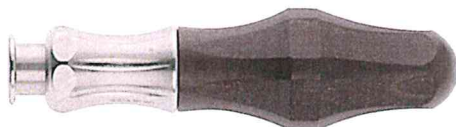

18120-40 Schraubendrehergriff, aus Ferozell,
 drehbar für alle Sorten Klingen
 Ferozell Screw-driver handle
 turnable, for all blades

18120-41 Schraubendrehergriff, aus Ferozell,
 nicht drehbar für alle Sorten Klingen
 Ferozell Screw-driver handle
 not turnable, for all blades

Instrumente für Mini-Platten-System, 2,0 mm
Instruments for Mini Plate System, 2,0 mm



18120-13

Schraubendreher, mit Metallgriff,
drehbar, selbsthaltend,
Screw-driver, with metal handle turnable
selfretaining, for cross lock screws Ø 2,0 mm



18120-23

Schraubendreher, mit Metallgriff,
drehbar, selbsthaltend,
für Vierkantschrauben Ø 2,0 mm
Screw-driver, with metal handle turnable
selfretaining, for square lock screws Ø 2,0 mm



18120-03

Schraubendreher, mit Metallgriff,
drehbar, Haltevorrichtung für Schrauben
Ø 2,0 mm Schlitz und Bohrung
Screw-driver, with metal handle turnable
holding device for screws Ø 2,0 mm,
single slot



18120-43

Schraubendrehergriff aus Metall
für alle Sorten Klingen
Metal Screw-driver handle
for all blades



18120-53

Schraubendreherklinge
alleine, selbsthaltend,
für Kreuzschlitzschrauben Ø 2,0 mm
Screw-driver blade
selfretaining, for cross lock screws Ø 2,0 mm



18120-54

Schraubendreherklinge
alleine, selbsthaltend,
für Vierkantschrauben Ø 2,0 mm
Screw-driver blade
selfretaining, for square lock screws Ø 2,0 mm



18120-51

Schraubendreherklinge
ohne Haltevorrichtung für Schrauben
mit Schlitz und Bohrung Ø 2,0 mm
Screw-driver blade, without holding device
for screws Ø 2,0 mm, single slot

18121-51

Schraubendreherklinge
mit Haltevorrichtung für Schrauben
mit Schlitz und Bohrung Ø 2,0 mm
Screw-driver blade, without holding device
for screws Ø 2,0 mm, single slot

Instrumente für Mini-Platten-System, 2,0 mm
Instruments for Mini Plate System, 2,0 mm



18120-52 Haltevorrichtung, für Schraubendreher
 Klinge für Schrauben mit Schlitz und Bohrung,
 für Titanschrauben Ø 2,0 mm
 Screw-holding device
 for screw driver blades single slot
 for Titan screws Ø 2,0 mm



18513-05 Tiefenmesser, Messertiefe 50 mm
 Depth gauge, measuring depth 50 mm



Spiralbohrer mit Stryker-Ansatz
Twist Drill with Stryker Coupling

- 18200-00 Ø 1,5 x 50 mm
für Schrauben bis 7 mm Länge
for screws up to 7 mm length
- 18200-20 Ø 1,5 x 70 mm
für Schrauben bis 20 mm Länge
for screws up to 20 mm length
- 18200-30 Ø 1,5 x 31 mm
für Schrauben bis 7 mm Länge
for screws up to 7 mm length
- 18200-40 Ø 1,5 x 105 mm
für Schrauben bis 20 mm Länge
for screws up to 20 mm length

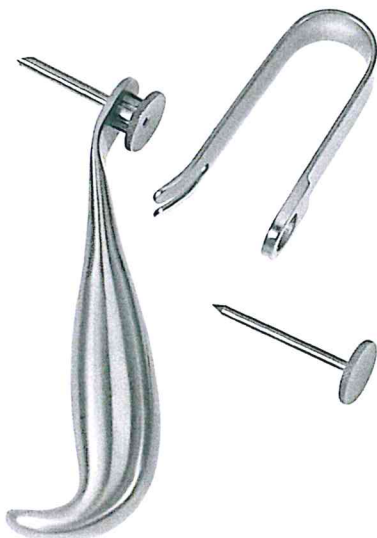

- 18803-00 Transbuccale Bohrhilfe
für Schraubendreher mit Haltevorrichtung
Transbuccal drilling guide
for screws-driver with holding sleeve
- 18803-50 Transbuccale Bohrhilfe
für Schraubendreher ohne Haltevorrichtung
Transbuccal drilling guide
for screws-driver without holding sleeve

